

SIEMENS

Betagard MCBs, RCCBs & DBs



With
SLR

All round protection guaranteed

Betagard MCB 5SL – Inspiring Safety

Answers for infrastructure.

www.siemens.co.in

Overview

As a culture Siemens has always endeavoured to introduce innovative products worldwide. The Electrical Installation R&D team has now raised the bar with the introduction of Betagard 5SL Miniature Circuit Breaker. Manufactured and designed at the Siemens Aurangabad facility, Betagard 5SL – *Inspiring Safety*, sets a new benchmark for protection.

Loaded with numerous features, Betagard 5SL is the only patented MCB with a unique **SLR** (Slide Latch-Release) feature for tool free removal of MCB from DIN rail. It also allows single MCB removal from a bus mounted assembly of MCBs. Betagard 5SL MCB is ergonomically designed and allows user-friendly switching. ON-OFF Status is easily recognizable thanks to the color coded switching position indicator on its attractive grey lever. With highly effective touch protection against accidental contact, Betagard 5SL range is available in current rating upto 63A in B and C characteristics.

Features and Benefits



Ergonomically designed, with a user friendly lever for effortless switching



Highly effective touch protection against accidental contact



MCB with patented unique **SLR** (Slide Latch-Release) feature for tool free removal from DIN rail. It also allows individual MCBs to be removed from bus mounted assembly

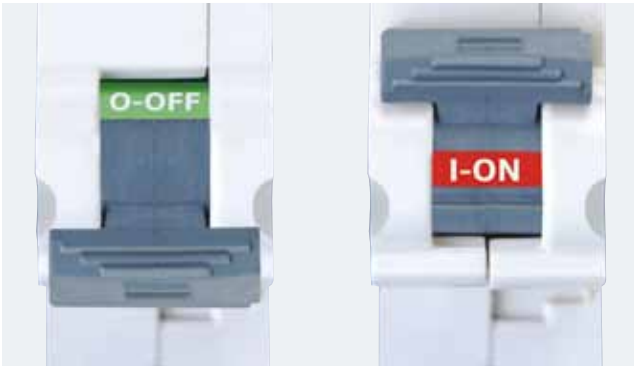

To highlight exact switching position, easily recognizable color coded ON-OFF is embedded on the attractive grey lever



BIS approval for ISI marking as per latest IS/IEC 60898:2002 for assured quality and protection

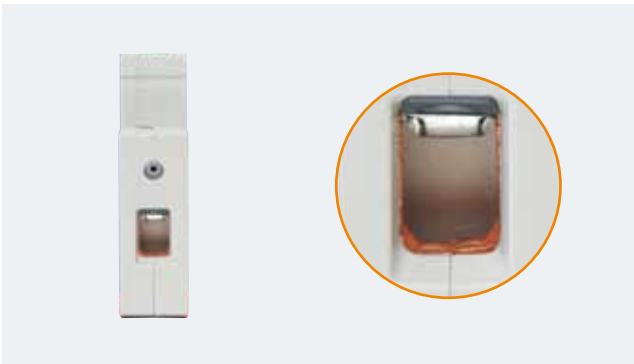

Uniquely designed square terminal to accommodate wire up to 35 Sqmm



Enables firm mounting of Bus bar together with wire and front access of wires for safer installation



Terminals can accommodate 2 wires of same cross section (Solid up to 2 X 10 mm² and finely stranded with end sleeve up to 2 X 4 mm²) without twisting wire strands facilitates easier and safe wiring



Side mounting accessories like auxiliary switches and fault signaling contacts available for special applications



Lever locking device with maximum 6 mm shackle



Green product – Recyclable, low watt loss, free from hazardous material like CFC and silicon (ROHS)



Technical Specifications

			Betagard 5SL
Standards			IS/IEC 60898-1 :2002
Tripping characteristic			B, C
Number of poles	1		✓
	2		✓
	3		✓
	4		✓
Rated voltage		V AC	240/415
Operational voltage	min.	V AC/DC	24
	max.	V DC/pole	60 ¹⁾
	max.	V AC	440
Rated breaking capacity	acc. to IS/IEC 60898-1	kA AC	7.5
Insulation coordination			
• Rated insulation voltage		V AC	250/440
• Degree of Pollution for overvoltage category III			2
Touch Protection	EN 50274		Yes
Degree of protection			IP20
CFC and silicone-free			yes
Terminals		Nm	2.5 ... 3
• Terminal tightening torque, recommended			
Conductor cross-sections			
• Solid and stranded		mm ²	0.75....35
• Finely stranded with end sleeve, max.		mm ²	0.75....25
Mounting position			any
Average Service life (with rated load)			20.000 operations
Ambient temperature		°C	-25 ... +45, occasionally +55, max. 95% humidity, storage temperature: -40 ... +75

¹⁾ The operational voltage 60 V DC/pole takes into account a battery charging voltage with peak value of 72 V





Selection and ordering data

7500	I_n A	Mounting width MW ¹⁾	Characteristic B Order No.	Characteristic C Order No.
MCBs				
	1P, 240/415 V AC			
	0.5	1	--	5SL61057RC
	1		--	5SL61017RC
	2		--	5SL61027RC
	3		--	5SL61037RC
	4		--	5SL61047RC
	6		5SL61066RC	5SL61067RC
	8		--	5SL61087RC
	10		5SL61106RC	5SL61107RC
	13		--	5SL61137RC
	16		5SL61166RC	5SL61167RC
	20		5SL61206RC	5SL61207RC
	25		5SL61256RC	5SL61257RC
	32		5SL61326RC	5SL61327RC
	40		5SL61406RC	5SL61407RC
	50		5SL61506RC	5SL61507RC
	63		5SL61636RC	5SL61637RC
	2P, 240/415 V AC			
	0.5	2	--	5SL62057RC
	1		--	5SL62017RC
	2		--	5SL62027RC
	3		--	5SL62037RC
	4		--	5SL62047RC
	6		5SL62066RC	5SL62067RC
	8		--	5SL62087RC
	10		5SL62106RC	5SL62107RC
	13		--	5SL62137RC
	16		5SL62166RC	5SL62167RC
	20		5SL62206RC	5SL62207RC
	25		5SL62256RC	5SL62257RC
	32		5SL62326RC	5SL62327RC
	40		5SL62406RC	5SL62407RC
	50		5SL62506RC	5SL62507RC
	63		5SL62636RC	5SL62637RC

¹⁾ 1 MW (modular width) = 18 mm.

Selection and ordering data

7500	I_n A	Mounting width MW ¹⁾	Characteristic B Order No.	Characteristic C Order No.
	3P, 415 V AC			
	0.5	3	--	5SL63057RC
	1		--	5SL63017RC
	2		--	5SL63027RC
	4		--	5SL63047RC
	6		5SL63066RC	5SL63067RC
	10		5SL63106RC	5SL63107RC
	16		5SL63166RC	5SL63167RC
	20		5SL63206RC	5SL63207RC
	25		5SL63256RC	5SL63257RC
	32		5SL63326RC	5SL63327RC
	40		5SL63406RC	5SL63407RC
	50		5SL63506RC	5SL63507RC
	63		5SL63636RC	5SL63637RC
	4P, 415 V AC			
	0.5	4	--	5SL64057RC
	1		--	5SL64017RC
	2		--	5SL64027RC
	4		--	5SL64047RC
	6		5SL64066RC	5SL64067RC
	10		5SL64106RC	5SL64107RC
	16		5SL64166RC	5SL64167RC
	20		5SL64206RC	5SL64207RC
	25		5SL64256RC	5SL64257RC
	32		5SL64326RC	5SL64327RC
	40		5SL64406RC	5SL64407RC
	50		5SL64506RC	5SL64507RC
	63		5SL64636RC	5SL64637RC

¹⁾ 1 MW (modular width) = 18 mm.

Accessories

Betagard 5SL miniature circuit breakers are suitable for mounting auxiliary switches and fault signal contacts. Lever locking device is also available for Betagard 5SL.

Auxiliary switches (AS)

The auxiliary switch (AS) always signals the contact position of the miniature circuit breaker, regardless of whether the miniature circuit breaker is tripped manually or as a result of a fault.

Fault signal contacts (FC)

The fault signal contact (FC) signals the tripping of the miniature circuit breaker in the event of a fault, such as an overload or a short circuit. The contact position does not change if miniature circuit breaker is tripped manually.

Lever locking device

MCB lever locking device is available for Betagard 5SL MCBs. MCB lever can be locked in ON or OFF position. Any lock of maximum 6 mm shackle can be used with this device.

Benefits





The Betagard 5SL miniature circuit breakers are ideal for the quick and easy mounting of auxiliary switches and fault signal contacts. Captive metal brackets ensure the quick and easy mounting of devices on the miniature circuit breakers without tools.

Technical specifications

		Auxiliary switches (AS) 5ST3 010	Fault signal contacts (FC) 5ST3 020
Standards		EN 62019; IEC/EN 60947-5-1; UL 1077; CSA C22.2 No. 235	
Short-circuit protection		Miniature circuit breaker or gG 6 A fuse	
Contact load			
• Min.		50 mA, 24 V	50 mA, 24 V
• Max.		--	--
• 400 V AC, AC-14, NO	A	2	2
• 230 V AC, AC-14, NO	A	6	6
• 400 V AC, AC-13, NC	A	2	2
• 230 V AC, AC-13, NC	A	6	6
• 220 V DC, DC-13, NO+NC	A	1	1
• 110 V DC, DC-13, NO+NC	A	1	1
• 60 V DC, DC-13, NO+NC	A	3	3
• 24 V DC, DC-13, NO+NC	A	6	6
Service life, on average, with rated load		20000 actuations	20000 actuations
Conductor cross-sections	mm ² AWG	0.5 ... 2.5 22 ... 14	0.5 ... 2.5 22 ... 14
Terminals			
• Terminal tightening torque	Nm lb/in	0.5 4.5	0.5 4.5

Selection and ordering data

		Mounting width MW ¹⁾	Reference No.
	Auxiliary switches (AS) 1 NO + 1 NC	0.5	5ST3010
	Fault signal contacts (FC) 1 NO + 1 NC	0.5	5ST3020
	For 5SL miniature circuit breakers For padlock with 3 ... 6 mm shackle		5ST3806

Rotary Handle Assembly for MCBs (ROH)

Benefits

- 5SJ, 5SY, 5SL, 5SP and 5TE8 series of MCBs/ Isolators can be fitted with Betagard Rotary Handle Assembly (ROH) for installation in Switchgear Cubicles and Distribution Panels
- The ROH gives operating uniformity and improves the aesthetics of the panel

- The ROH can be padlocked in OFF position with the help of suitable padlocks thereby ensuring complete safety to operating personal during maintenance
- Door interlock and defeat facility is available as a standard feature.

Applications

- Panel Boards / Switch Boards

Technical Details:

	Product	Reference No
	Rotary Handle Assembly for MCB	5ST38140RC

¹⁾ 1 MW (modular width) = 18 mm.

More information

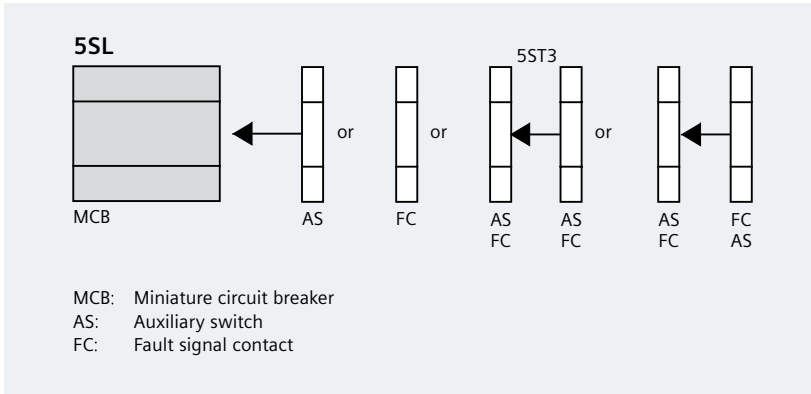

Dimensional drawings

5SL

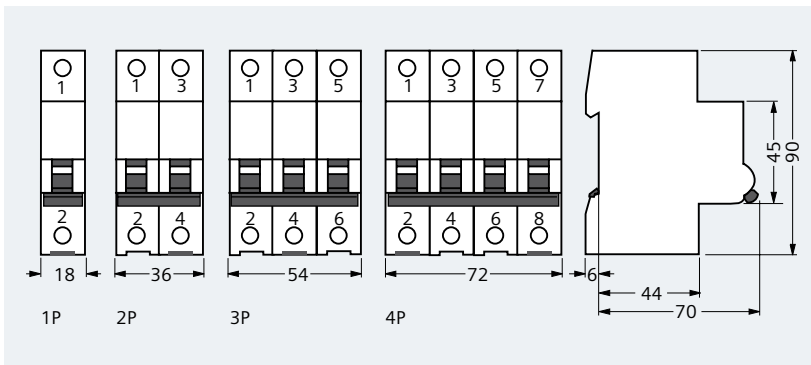

5ST3 010
5ST3 020

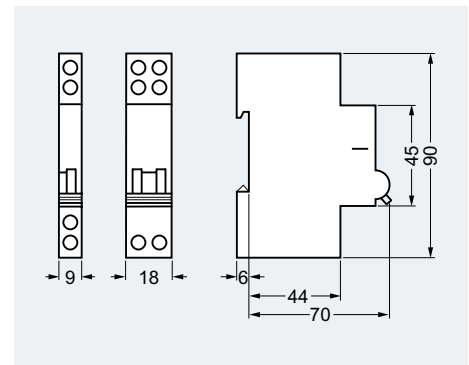

Schematics

Symbols

5SL

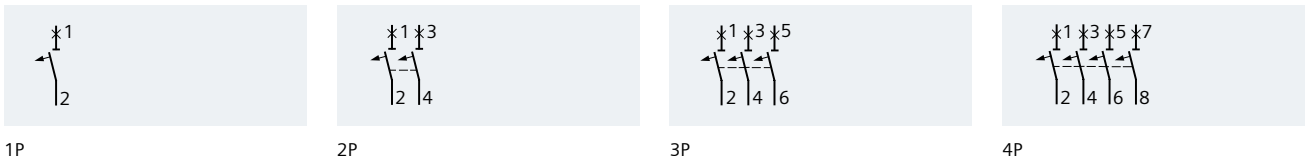

Auxiliary switches (AS)

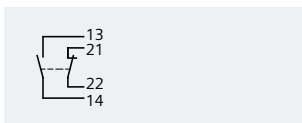

5ST3 010

Fault signal contacts (FC)



5ST3 020

Application

'B' Characteristics

'B' Characteristic MCBs react quickly to overloads, and are set to trip when the current passing through them is between 3 to 5 times the normal full load current. They are suitable for protecting incandescent lighting and socket-outlet circuits in domestic and commercial environments, where there is little risk of surges that could cause the MCB to trip.

'C' Characteristics

'C' characteristics MCBs are used for protection of electrical circuits in general and are most widely used because of its suitability for practically all electrical circuits, cable and line protection. They are capable of supplying the majority of inductive and capacitive loads including most motor and fluorescent lighting loads.

This characteristic allows applying loads having high peak currents without requiring the MCB to be oversized. In fact, thanks to this characteristic, it is possible to apply loads with peak currents up to 5 times I_n , (rated current) and can hence be used to best advantage for handling higher inrush

currents e.g. lamps, motors, etc. Under 'C' characteristics, the magnetic operating limits (for short-circuit operations) are between 5 and 10 times the rated current (I_n) of MCB. For example the instantaneous mechanism of a 10A MCB will operate between 50A and 100A in an overcurrent situation. The thermal operating limits (for overload operation) are between 1.13 and 1.45 of the rated current (I_n) of the MCB.

DC Operation

Single pole MCBs can be used up to 60V DC and double pole up to 110V DC.

However, they should not be used below 18V DC. Though the thermal operation is delayed but this is negligible. The instantaneous tripping characteristic must be increased by 40% (e.g. a Type 'C' MCB has a magnetic tripping characteristic between 5 and 10 times the rated current). This magnetic tripping characteristic would therefore become between 7 and 14 times the rated current.

Characteristic curves

Tripping Characteristics as per IS/IEC 60898-1:2002

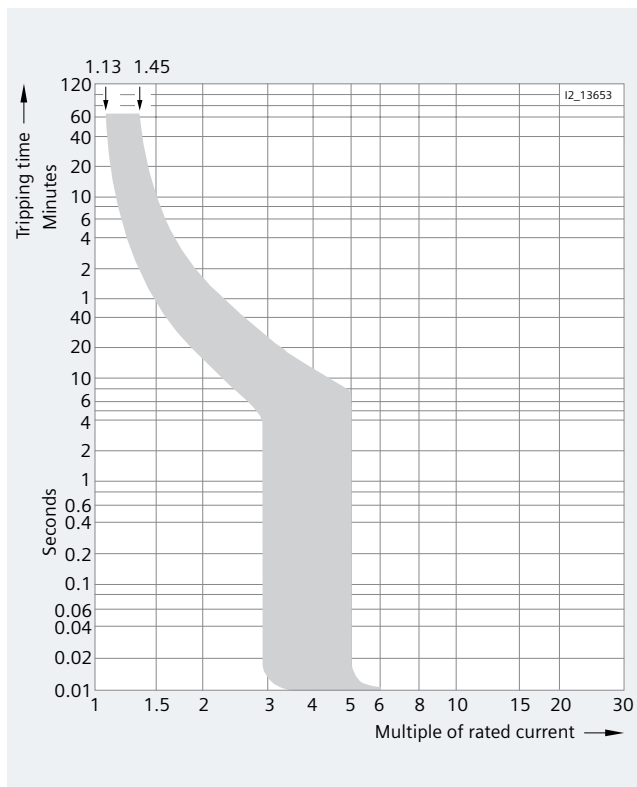

Tripping characteristic B

MCBs with this tripping characteristic are designed for universal use in socket outlet and lighting circuits.

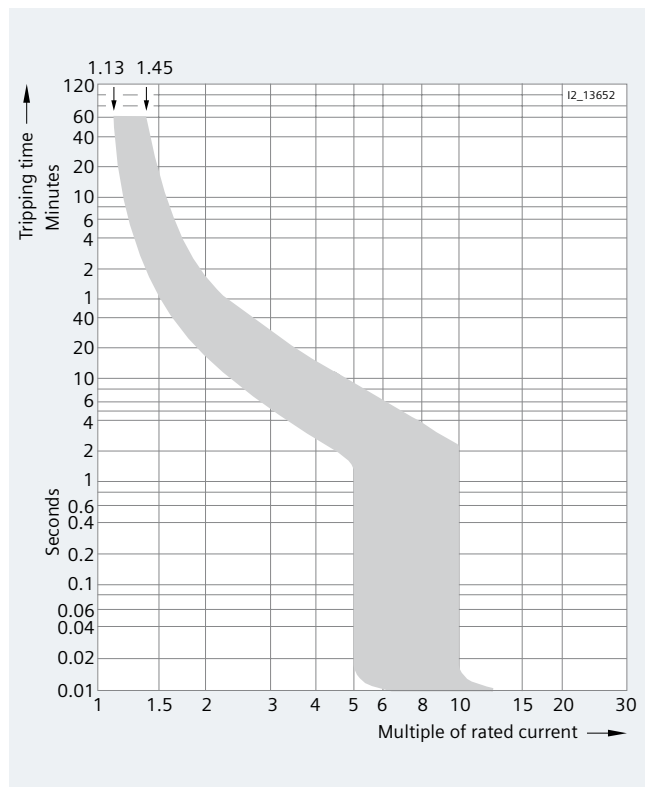

Tripping characteristic C

In lamp and motor circuits with higher starting currents, MCBs with tripping characteristic C are generally used.

Tripping characteristics

Tripping characteristics at an ambient temperature of 30°C

Tripping characteristic	Standards	Thermal trips Test currents:				Electromagnetic trips Test currents:		
		Limiting test current I_1	Minimum test current I_2	Tripping time $I_n \leq 63 \text{ A}$ t	$I_n > 63 \text{ A}$ t	Hold I_4	Latest tripping instant I_5	Tripping time t
B	IS/IEC 60898-1, DIN VDE 0641-11	$1.13 \times I_n$	$1.45 \times I_n$	> 1 h < 1 h	> 2 h < 2 h	$3 \times I_n$	$5 \times I_n$	$\geq 0.1 \text{ s}$ < 0.1 s
C	IS/IEC 60898-1, DIN VDE 0641-11	$1.13 \times I_n$	$1.45 \times I_n$	> 1 h < 1 h	> 2 h < 2 h	$5 \times I_n$	$10 \times I_n$	$\geq 0.1 \text{ s}$ < 0.1 s

Internal power loss P_v of the miniature circuit breaker 5SL6

(Data per pole with I_n)

I_n	Requirement of IS/IEC 60898		Characteristic B		Characteristic C	
	P_v	W	P_v	W	P_v	W
5SL6						
0,5	3		--		0.9	
1	3		--		1.2	
2	3		--		1.2	
3	3		--		1.2	
4	3		1.45		1.3	
6	3		1.15		0.6	
8	3		--		0.7	
10	3		1.5		1.2	
13	3.5		--		1.8	
16	3.5		1.9		1.7	
20	4.5		2.2		1.7	
25	4.5		2.3		2.2	
32	6		2.4		2.5	
40	9		3.4		3.3	
50	9		3.8		3.5	
63	13		5.4		4.4	

